

**SAMSUNG**

# PANGO(PL40) Series

**Model:** *SP0221N*  
*SP0311N*  
*SP0411N*

## ***HARD DISK DRIVE service manual***

**Hard Disk Drive**

**Contents**

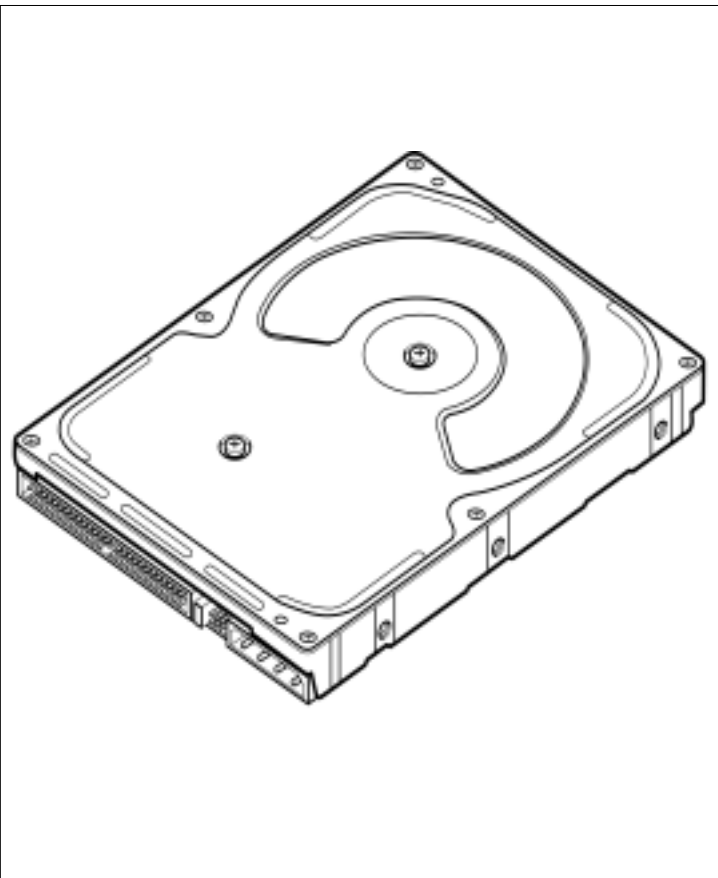

1. Specification summary
  2. Block Diagram of HDD
  3. Connector & Jumper Pin Assignments
  4. Exploded View
  5. Maintenance Cylinder Configuration
  6. How to use LEO Program
  7. How to progress Burn-In Test
  8. Caution
- Attachment 1. The basic information related HDD
- Attachment 2. HDD related terms
- Attachment 3. Q&A

## 1. Specification Summary

Items	Specification	Remarks
Voltage Requirement	DC +12V/±10%, DC +5V/±5%	
Interface	ATA - 6	
Capacity	SP0221N - 20.0GB (1CH) SP0311N - 30.0GB (1CH) SP0411N - 40.0GB (1CH)	UDMA133supporting(UDMA100 Default)
Disk / Head	SP0221N - 1/1(disk/head) SP0311N - 1/1(disk/head) SP0411N - 1/1(disk/head)	
Features	S.M.A.R.T Compliant Buffer size 2 Mbytes MTBF(POH) 500,000 hours	
Seek Time (RD/WT typical)	Track to Track : 1.0 / 1.2 ms Average : 10.0 / 12.0 ms Full Stroke : 17.5 / 19.0 ms	
RPM	7,200 ± 0.35 % RPM	
Temperature (Operating)	5 ~ 55°C	
Humidity (Operating)	5 ~ 90 %	Non-condensing
Temperature (Non-operating)	- 40 ~ + 70 °C	
Humidity (Non-operating)	5 ~ 95 %	
Linear Shock (Operating)	63 G @2.0ms	Linear Shock
Linear Shock (Non-operating)	350 G (2ms linear shock)	

## 2. Block Diagram of HDD

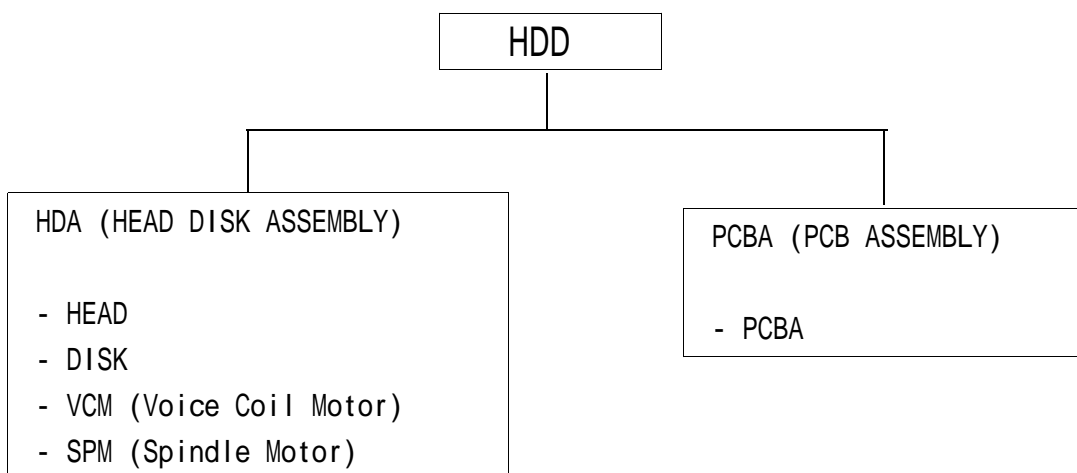
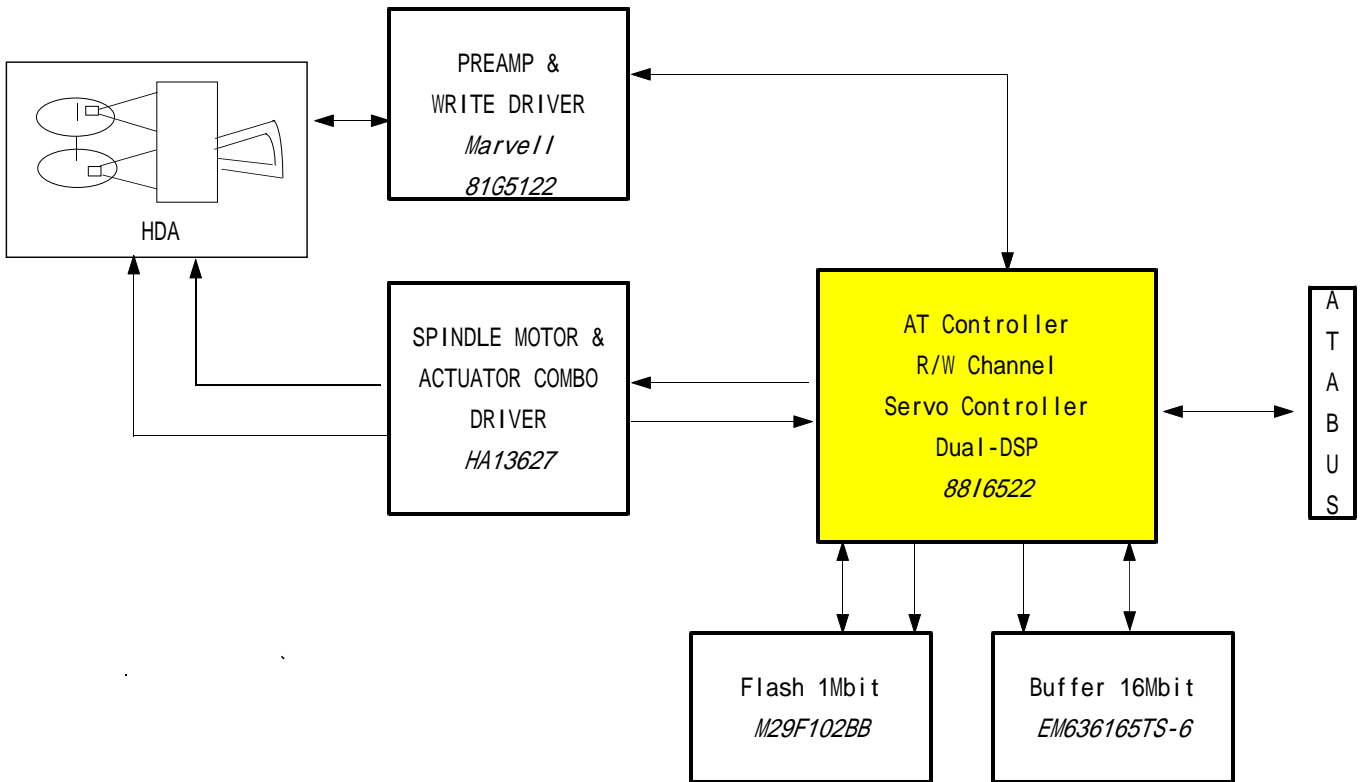

### 3. Connector / Jumper Pin Assignment

#### 40 Pin I/O Connector Interface Signals

Number	Signal	Number	Signal	Remarks
1	RESET-	2	GND	
3	DD7	4	DD8	
5	DD6	6	DB9	
7	DD5	8	DB10	
9	DD4	10	DB11	
11	DD3	12	DB12	
13	DD2	14	DB13	
15	DD1	16	DB14	
17	DD0	18	DB15	
19	GND	20	Key Pin	
21	DMARQ	22	GND	
23	DIOW - : STOP	24	GND	
25	DIOR - : HDMARDY : HSTROBE	26	GND	
27	IORDY : DDMARDY : HSTROBE	28	CSEL	
29	DMACK	30	GND	
31	INTRQ	32	IOCS16	
33	DA1	34	PDIAG - : CBLID -	
35	DA0	36	DA2	
37	CS0-	38	CS1-	
39	DASP-	40	GND	

#### Jumper Pin Assignment

+ G G +  
 12 N N 5 PCBA components side  
 V D D V JUMPER PIN

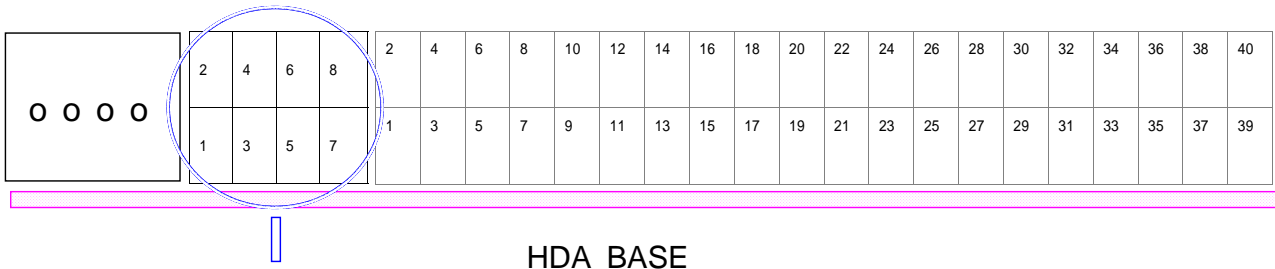

<input type="checkbox"/>	<input type="checkbox"/>	<input type="checkbox"/>
S C S M T S L A E A S L V T E E R	S C S M T S L A E A S L V T E E R	S C S M T S L A E A S L V T E E R
MASTER (1DRIVE)	SLAVE	CABLE SELECT

**< Jumper Pin Setting for  
SP0221n,SP0311N>**

<input type="checkbox"/>	<input type="checkbox"/>	<input type="checkbox"/>	<input type="checkbox"/>	<input type="checkbox"/>	<input type="checkbox"/>	<input type="checkbox"/>	<input type="checkbox"/>
S C S M T S L A E A S L V T E E R	S C S M T S L A E A S L V T E E R	S C S M T S L A E A S L V T E E R	S C S M T S L A E A S L V T E E R	S C S M T S L A E A S L V T E E R	S C S M T S L A E A S L V T E E R	S C S M T S L A E A S L V T E E R	S C S M T S L A E A S L V T E E R
MASTER (1DRIVE)	SLAVE	CABLE SELECT	MASTER (1DRIVE)	SLAVE	CABLE SELECT	MASTER (1DRIVE)	SLAVE

**< Setting for SP0411N >**

**< 32GB Capacity Limit of PC/BIOS >**

BIOS Setup Parameter

	CYL	HD	PRE	LZ	SEC	SIZE	
SP0221N	38,870	16	X	X	63	20.0 GB	39,180,960
SP0311N	58,246	16	X	X	63	30.0 GB	58,711,968
SP0411N	77,622	16	X	X	63	40.0 GB	78,242,976

### 4. Exploded View

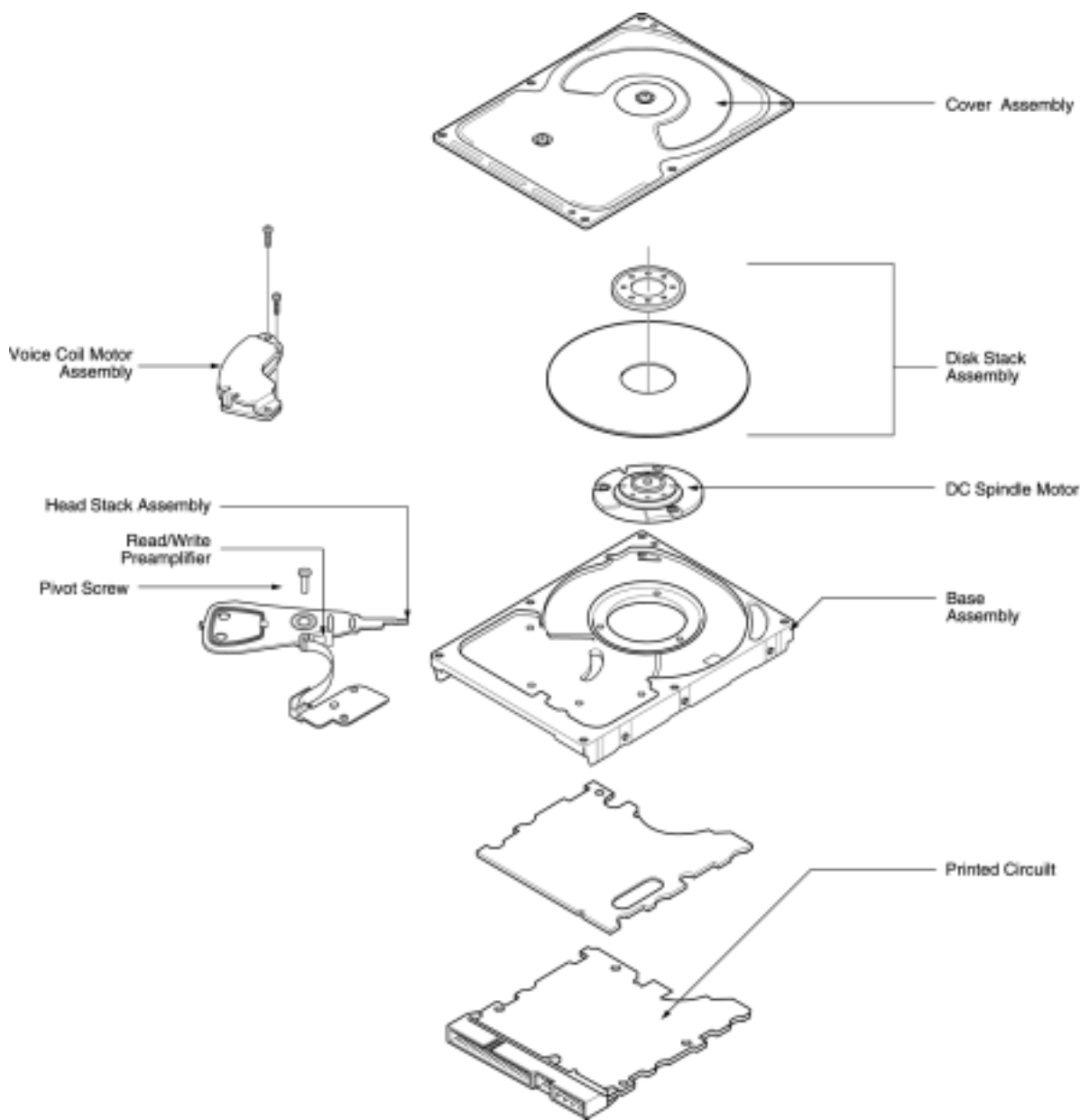

## << Major components of HDD >>

HDD is formed by major components as follows: Base, Cover, ARM(E-Block), Latch, Crash Stop, Pivot Bearing, Breather Filter, Window Clock, Window Push Pin, Jump Pin, Spindle Motor, Actuator, Magnetic Head, Magnetic Disk, PCBA

### Base

Base could be a basic frames for HDD assembly. Spindle motor, ARM, VCM, cover and PCBA are assembled on it, and other components are sub-assembled on those configuration. ARM and Spindle motor assembled to Head and Disk each in advance, then those are assembled on Base. If base could be effected by external and internal vibration (spindle motor & actuator's fake vibration), relative displacement occurred between head and disk so to reduce this effect to PES(Position Error Signal) and data signal, shape design concerned mode shaping should be needed.

### Cover

Cover protect HDD components from the exterior impact and play role of sealing to cut off particle and moisture which could be a fatal factor to head and disk. Cover is also designed in consideration of noise and vibration effect.

### ARM (E-block)

ARM is assembled HGA and VCM coil back and forth and it is connected to pivot axis pivot bearing. When VCM coil generate torque due to electromagnetic force of VCM, ARM swing around pivot and play a role of carriage so as head may access to information side of disk.

*Inertia:* It is the best way to shorten data access time that shows how fast head can reach to the proper point on of HDD efficiency, is minimizing ARM's weight to decrease inertia. And then to decrease weight of ARM, it'll be composed low density materials and reduce ARM's size within safety allowed when designed.

*Unbalance:* If the center of gravity for ARM isn't the same with that of pivot center, unbalance occur and it caused ARM to torque. And acceleration might affect on unbalance mass in condition impact or vibration are given from the exterior. In case of magnetic latch, this unbalance could be a reason that latch released. Therefore shape simulation of ARM should be designed lest the center of gravity should go off center of revolving.

### Latch

When power HDD off, spindle motor stop spinning and park at parking zone automatically according to the order systemized. By that time if head is given any impact or vibration from the exterior, head invade data zone clung to disk. And then data damaged consequently, Latch solve the problem above as maintain the regular distance of ARM.

#### Crash Stop

Crash stop is made of elastic material and weakens the impact of actuator in emergency condition, head getting out of data zone when it moves to parking zone or seek.

#### Pivot Bearing

Pivot bearing is a roll bearing fixed to the center of gyration of ARM. Inner Race is fixed by screw after being connected to Base pivot and outer Race is fixed by retaining ring after being connected by ARM's hole and makes the ARM's revolving movement actively.

#### Breather Filter

In the interior of HDD, air flow is formed by the spinning disk in high speed and pressure distribution occurs. This pressure is lower than atmospheric pressure of the exterior of HDD and due to this, the outside air inflow into the interior causes contamination.

Breather filter fixed in inflow plug induces clean air and helps air circulation.

#### Window Clock

Head must know the data's location information to access data on disk. Servo write is a process of recording information on disk. To record information, we make a hole that head for servo write can enter the interior of HDD and this hole is window clock.

This hole is closed with sealing label after done servo writing, be careful not to be occurred inner contamination due to label's injury.

#### Window Push Pin

Head should be controlled to move on disk at a regular track pitch interval rate during servo writing. ARM is torqued by VCM continuously and is controlled each track's moving using push pin. Window push pin is a hole for this, the pin could enter interior of HDD and be careful contamination caused by label's injury because this hole is closed by sealing label after done servo writing.

#### Jump Pin

During installing, HDD needs setting of pin organization in the next according to the drive running mode: master drive in single system, master drive in dual system, slave drive in dual system.

#### Spindle Motor

Spindle motor is a sort of small motor which can change electric energy to mechanical energy utilizing for magnetic field. When the current of stator's coil formed by electromagnet is on, magnetic power occurs between stator and rotator. (repel occurs between same pole and attract occurs in case of different pole) This power can make rotator revolve and we should keep on changing the magnetic pole of the stator to maintain rotation at regular speed.

To progress this function, we deduct rotation speed and circuit for controlling needed.

It is possible to control the current flow and time interval with Hall element and MR



element (these are sensitive to voltage change). The magnetic disk of hard disk is running by DC Brushless direct drive motor directly. Brush has long life and high reliability because it doesn't have belt. Recently we use flat motor to be adopted to the request of minimizing. The rotation bearing is supported by Fluid Dynamic Bearing(FDB), this is not keeping high speed spinning but also reducing resistance even eliminating and this make the acceleration better.

The life of hard disk is up to the durability of this bearing supporting revolving axis. Spindle motor rotate a disk media at regular speed. This device start to rotate as soon as put power on and no matter what HDD read or write data, spindle motor always revolve. Besides accurate reading from the media point of view is possible when maintain the constant speed within 0.1%, rotation error. The control circuit of spindle motor receive the index data from the spindle motor or media at every spin and check whether constant speed persists or not then revise the speed. Spindle motor is applied to DC brushless motor.

#### Actuator

Hard disk has 2 disks so it has 4 written sides, and each side needs each written replay device, 8 heads needed. This 4 heads can't work independently. Each head is connected with one carriage and set as running altogether. For example, one head move at tenth track and then the rest come to move at the same track. Retrieval (information searching) is a moving the head to track properly. The faster searching speed, the better for a quick access. It is profitable to use voice coil motor for a fast searching speed. Making narrow the width and interval of track is for HDD capacity improvement so we can build more tracks on written side so searching movements in head become subtle. Therefore servo control the decision of HDD location. Magnetic disk is put standard signal for location marking from the manufacturing step. Head read this to find the relative difference then run motor mediate the head's location.

#### Magnetic Head

Magnetic field is formed around the conduct on passing electric current to conductor and the direction and size of magnetic field are decided by those of an electric current. Magnetic head build a minute gap in core (formed by ring) and pass an electric current then strong magnetic leakage are occurred around gap thus magnetic particles of media vary the direction according to the that of current: this is called recording. On the contrary, a process induce magnetic signal to electric signal is called reading (decipherment).

#### Magnetic Disk

Recording carrier become a permanent magnet according to applying magnetic material to the surface and change the magnetization direction of a electromagnet and it is possible to store information during long term.

#### PCBA

PCBA is a circuit element concerning about HDD running and constructed in engine IC, COMBO IC, read/write IC, ROM, and sort of chip etc.

- Engine IC: contained RAM & Interface IC and exchange information to computer.
- COMBO IC: Controlling spindle motor & VCM running when HDD power on.
- Read/Write IC: read/write of HDD

- ROM: Checking HDD basic function and management basic spec.

## 5.Maintenance Cylinder Configuration

Contents	Disk Location	sector size	Header
CTBL	4, 0, 131	8	CHN_TB3
IDFY	0, 0, 1	1	
IDFY	0, 0, 1	3	
MLIST	0, 0, 6	1	MLIST
SRVTBL	0, 0, 7	3	SV_TBL
CONFIG	1, 0, 1	2	CONFIG
SNTBL	1, 0, 3	2	
BISPT	1, 0, 5	4	
BRSLT	1, 0, 10	1	
FINALTST	1, 0, 12	8	
FINALTST	1, 0, 19	8	
CTBL	1, 0, 30	8	CHN_TBL
VLISTHDR	1, 0, 78	1	VLIST_H
VLIST	1, 0, 79	16	
SLISTHDR	1, 0, 111	1	SLIST_H
SLIST	1, 0, 112	128	
TLIST	1, 0, 368	4	TLIST
ALIST	1, 0, 372	8	RLIST
TMPRTR	1, 0, 395	2	TMPRTURE
MRTUNE	1, 0, 383	3	SV_TBL2
ARCOTBL2	1, 0, 387	8	CHN_TB2
LATCHFRC	4, 0, 4	1	LATCH_FC
BTIME	4, 0, 91	2	BI_TIME
ERRTRK	4, 0, 56	1	BER
ERRZN	4, 0, 57	1	BER1
ERRDRV	4, 0, 58	1	BER2
SRTDATA	4, 0, 59	1	ER_CNT
SRTSRVO	4, 0, 60	1	SV_ERCNT
PARAM	4, 0, 62	10	
TSTPI	4, 0, 82	4	TPI_WRW
MRTUNEMT	4, 0, 86	5	MR_TUNE
DLIST	3, 0, 1	768	
BPI	4, 0, 521	8	AZL_BPI
BPICSM	4, 0, 513	8	AZL_CSM
CURGEO	4, 0, 512	1	CUR_BPI
SMART	11, 0, 1	8	SMARTMEM
SEL	11, 0, 2	4	
ELOG	12, 0, 1	768	
RCOHDR	5, 0, 1	2	RCOHDR
RCODATA	5, 0, 1	256	RCODATA
SKEW	0, 0, 2	1	SKEW
CRITERIA	0, 0, 11	1	
MRSKEW	0, 0, 189	1	MRSKEW
SMTBL	0, 0, 192	1	SM
UNITABLE	0, 0, 197	2	UNITABLE
SETMAX	0, 0, 233	1	SETMAX
D_CSM	3, 0, 2	252	
WB_RLT	0, 1, 5	1	WB_RLT
GAIN	0, 0, 691	1	GAIN
WKHEAD	4, 0, 72	4	WK_HEAD
NPV	4, 0, 77	4	
HIT	4, 0, 533	4	

## 7. How to use HUTIL Program

### 1) Before you start

HUTIL support from Voyager11P to VERNA series.(HUTIL 1.09 version)

(HUTIL has been upgrading constantly whenever new model comes out.)

- Preparation before use

Diskette or HDD containing HUTIL.EXE should be boot-up to MS-DOS mode,that is, should be contained IO.SYS, MSDOS.SYS,COMMAND.COM (IO.SYS, MSDOS.SYS: hidden file).

And also HUTIL.CFG is required.

### 2) Explanation of each menu

OPTION - ABOUT HUTIL : Version of HUTIL.

OPTION - DOS SHELL : Execute DOS Shell. If you want back to HUTIL, input EXIT.

EXIT TO DOS : End HUTIL program.

OPTION - DRIVE INFORMATION : Open the information window about the target HDD.

Press **ESC** to close.

TEST - READ ALL: Display error list when error is occurred after reading whole cylinder.

Message will be appeared if the test time delay is over 20 seconds compared with other normal HDD. In this case, HDD may have problem. (Progress sequential read test from cyl. #0 to the last cylinder. No Defect Free. - Refer to attachment below.)

TEST - READ FROM : Read from the designated cylinder and head to the last cylinder.

Press **ESC** to stop in the middle.

TEST - WRITE ALL: Write 00h on all cylinder except maintenance cylinder.

All data will be removed. (Even partition table, boot sector & FAT)

TEST - WRITE FROM : Write from the designate cylinder and head to the last cylinder.

INFORMATION - NEW DEFECT LIST : View the error list in memory.

TEST - BURN IN : Download burn-In script to HDD.

TEST - DEFECT FREE : Progress after **Read Drive** command.

Defect free operation for the defects in the error list.

TEST - SHORT TEST : Menu for random read test, no defect free test.

TEST - LONG TEST : Read test from the first cylinder to the last in order, no defect free test.

TEST - LONG TEST & DF : Current auto test.Check defect and defect free during read test and examine defect free again.

INFORMATION - NEW DEFECT MAP : Show defect on drive in graphic mode. These defects are invisible because of done then these are added after defect free done B/I & Read test or Auto test separately.

INFORMATION - GROWN DEFECT MAP : Show the defects in graphic mode during HUTIL program.

Moving along cursor with up/down arrow key, these keys are indicated the location of defects in the right list on disk. This location is agreed with the real location because skew was concerned in that already.

The color of an arrow is agreed with those of head in

which defect occurred.

This function is applying to Voyager10,11,11P currently and this function can't show the defects during process.

### 3) The others

#### - Difference of read test and auto test

(Difference from HUTIL user, refer to supplement )

How to Read All/From Test: In "read all test" case, only show error status on screen not to progress D/F(defect free) but to read. This method is available for test in case of lots of set because we can save D/F time if defects are occurred.

In case of S/C in Europe(All-in), progress the test by using read test(F2).

First, progress "all read" and if defect is occurred during progress, decide failure or B/I judgment quickly to select set promptly in state fail limit and B/I limit are decided according to defect numbers. This progress is available for test in case of lots of set. A weak point is that limit is hard to be decided because LED user judge "pass" or B/I "failure" for himself.

Pass standard of EDC in case of S/C in Europe(All-in)

: Progress test defects are occurred no more than 0 4 progress D/F judge "pass".

- Standard of B/I test: Progress test defect is occurred less than 5 200 judge B/I test after B/I down loading.

- Failure standard: Progress test defect is occurred more than 200 failure (little bit differ from real case because the standard is a example which HUTIL user progress the test after data analysis.)

How to Short/ Long Test : Head check PES check M/C check media check

If defect is occurred during media test, progress D/F keeping on test progress.

In case of Auto test, failure code is appeared on screen so failure is judged commonly.

It takes lots of times because defect is progressed whenever error occurred.

Two methods above have weak and strong point both, so apply these to proper condition.

#### - Standard of failure judgment (Auto test)

Head Check

Write Head: All heads are progressed to write at the last cylinder (ID region).

If it is fail to write due to cylinder error, progress again in the next inner cylinder.

Record failure status to the corresponding head after progress error check to all 10 cylinders.( e.g.: Head 0 Fail, Head 1 Pass ... )

Read Head: Seek 100 cylinders per OD, MD, ID regions remark "failure" if error occurred in 3 times per region. ( Judge failure by reading not the whole cylinder but servo sector only because it is apt to mistake failure to head failure due to scratch)

PES Check (PES, RCO, Mechanism)

: Compare PES value from the first cylinder starting OD(except MC ),MD,ID region to the 3rd

cylinder. (Check 30 times per 1 cylinder) Remark "failure" when error occurred more than 3 times per 1 cylinder.

Maintenance Cylinder Check(M/C): Read Maintenance cylinder from the number of 0 to the last. In case of "MC", remark "failure" when error happened in one time.

Media Check

: Read from OD to ID region same as the existing read test function and progress "D/F" whenever defect occurred.

Auto Defect Free: Reading along OD to ID region, progress "D/F" promptly if defect occurred.

Read the next sector if no defect occurred and progress D/F if defect occurred.

When we don't have any more cylinder space for D/F, stop progressing D/F and then remark defect status for the next 30 defects occurred from the D/F stopping location.

Remark failure:

- If the number of defects are same in OD,MD,ID region  
remark failure in order of OD > MD > ID.
- If the number of defects are different in OD,MD,ID region  
remark failure in region have the most defects among OD,MD,ID region  
continuousness: Continuous scratch more than 15 cylinders  
divergence: Divergent scratch less than 15 cylinders

Test OK: Remark "Test OK" if no problem occurred when test done.

If it passed due to D/F, remark "Defect free by pass~" and show the corresponding failure region in the below. At this time, input the code of failure region shown and the control code 'is a "Defect controlled".

Display Read time with checking during Read test,

(Stop reading if expecting read time exceeded +10 when 50 % tested.)

## 7) HUTIL Error message

Error messages

- ECC ERROR: Where the data was written (data writing dimension in sector, data zone) occur physical damage (hard related error: disk ding by head caused by impact and vibration) or logical damage. (soft related error: error is occurred during writing) Logical error(damage) could be cured by re-writing.
- DATA AM NOT FOUND ERROR: Damaged address mark(AM:current address information of data) among the structure of sectors, containing the logical and physical defect.
- ABORTED COMMAND: Message when HDD can't recognize the fixed order in program. (PCBA failure or HDA failure.)

Example of disk failure

Most of case,defects(cylinder)are sporadic or continuous but if defects are partly -continuous, disk could be judged disk failure.

It is called the continuous defects "scratch" it means that head is scratched the disk side in the direction of arc or straight due to impact or vibration after motor run.

Example for Head related failure

**< Error List >**

CYL	HD(Head)	SEC	Error List
1	0	117	ECC Err
2	1	106	Data Am Not Found
3	1	110	ECC Err
4	2	12	ECC Err
117	1	13	ECC Err
120	2	152	ECC Err
159	3	102	ECC Err
170	1		
171	1		
172	3		
173	1		
174	2		
190	2		
191	1		

**< Error List >**

CYL	HD(Head)	SEC	Error
1	1	117	ECC Err
2	1	106	Data Am Not Found
3	1	110	ECC Err
4	1	12	ECC Err
5	1	13	ECC Err
6	1	152	ECC Err
7	1	102	ECC Err
8	1		
9	1		
10	1		
11	1		
12	1		
13	1		
14	1		

Compared with disk failure, head related failure occur in particular HD(head) from the first cylinder and this is occurred continuously.(it is occurred in two more heads)

If failure is continuous, we are confused if it is head failure or disk failure. At this time

read the edge of cylinder again then it is head failure if error still be continuous at the

particular head and disk failure in sporadic case. And failure occurred with changing cylinder and head continuously, it is called assembly failure in inner HDA or caused from other problem. (HDA related failure )

CYL	HD(Head)	SEC	Error
1	1	117	ECC Err
1	2	106	Data Am Not Found
1	3	110	ECC Err
1	4	12	ECC Err
2	1	13	ECC Err
2	2	152	ECC Err
2	3	102	ECC Err
2	4		
3	1		
3	2		
3	3		
3	4		
4	1		
4	2		

**HUTIL Test Flow/Error**

Codes marked as red among broken codes are displaying automatically in HUTIL Program!

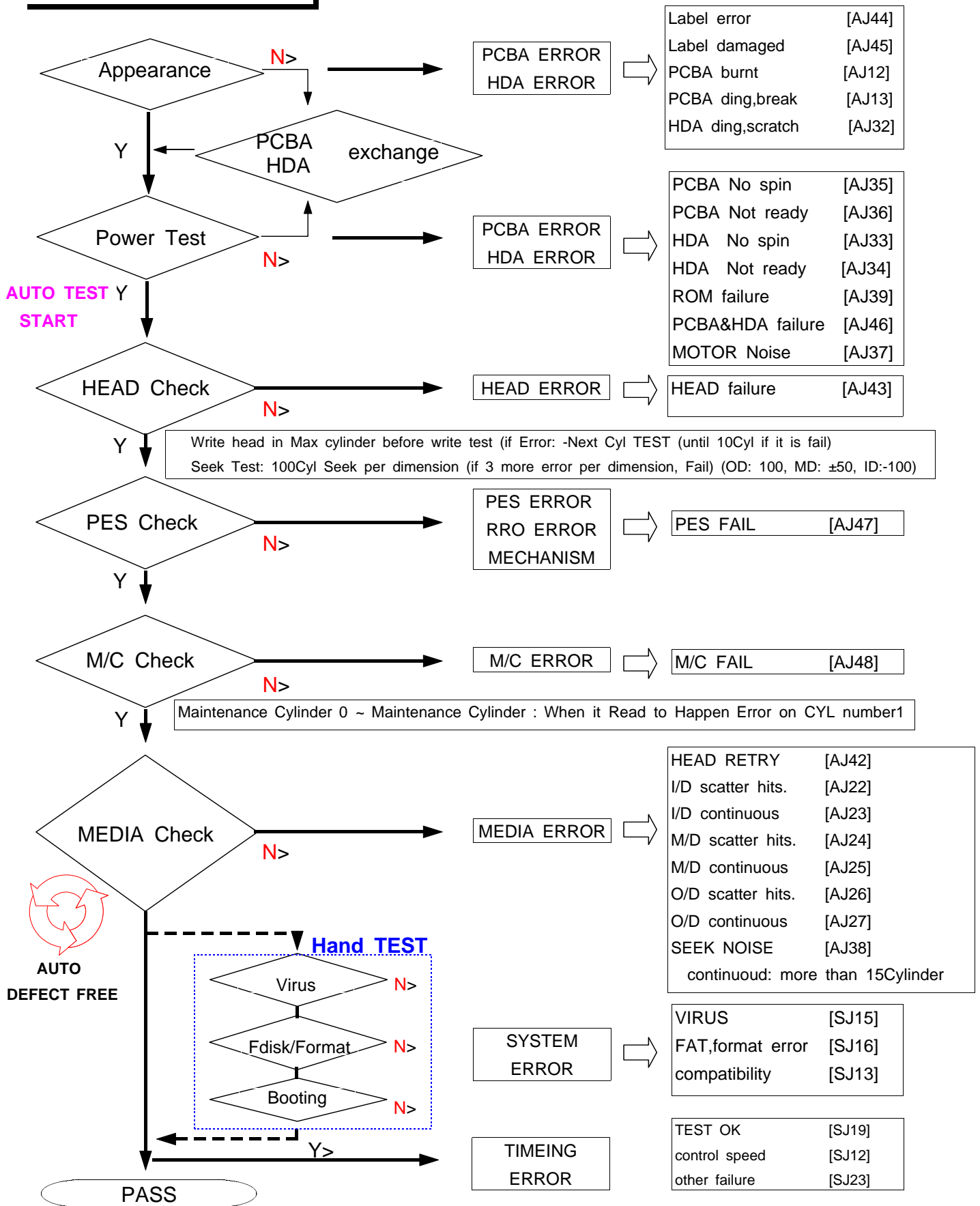



## Explanation of terms for HDD repairing

	CONTENTS	SYMPTOMS
NOT READY (NR)	When HDD power on, LED is in on and motor start to drive. At this time head make vibration and start to drive then stop the vibration and led is off at the same time.	Motor doesn't drive. Led is still on/off mode when power on : PCB failure Led is still in on mode and doesn't make any vibration.
DISK DEFECT	Symptoms for damage at disk side	ID,MD,OD failure is occurred in HUTIL test process rate 0 33% OD 34 66% MD 67 100% ID
ID	Defect is occurred at the inner part of disk	
MD	Defect is occurred at the middle part of disk	
OD	Defect is occurred at the out part of disk	
MAINTENANCE CYLINDER DEFECT(MC)	Part of basic information like defect etc. in HDD	Maintenance cylinder defect
SPIN MOTOR NOISE(SM)	Motor rotate disk and if it is impacted ,make a big noise due to damage.	When power on, some irregular noise is occurred at general motor.
ERASED TIME	how many times does it cost to progress read test in HUTIL actually	This is SUFFECTED in drive
NORMAL TIME	Prescribed read test time by product company.	
AUTO TEST	Read and defect free are progressed automatically.	ALT+A Key
DEFECT FREE	Transfer defect on disk into buffer cylinder on disk. Defect isn't available for read/write	OD,MD,ID is occurred when defect free error and exceed the capacity to progress defect free. F6 Key
READ TEST	Read wether damage on the disk side or not	F2 Key
WRITE TEST	Write the regular data on disk side.	F4 Key
DELETE SYSTEM	Erase all the previous Data entirely at HUTIL test pass product.	F7 Key
PES	HEAD is located at cylinder of disk correctly and is tested write ,read is available.	HUTIL test PES fail
BURN IN TEST	Repeat read,write for with many hours and progress defect free finally for the product confidence.	Product which CD,MD,ID defect is occurred in HUTIL test is downloaded(head test)by ALT-I and if it is passed ,only power on needed.Repeat led once is pass, fail when fail happen once more.
HUTIL TEST	To check defect of HDD, svc tool, read,write,head,pes are manufactured to test defect and this is available for defect free and other variable test.	Check menu with F10 Key. Refer to HUTIL manual for usage

## 7. How to progress Burn-In Test

### 1) Summary of B/I Test

Progress defect detection and reliability test of HDD according to program written in maintenance/cylinder in temperature  $40 \pm 5$  , humidity  $50 \pm 10\%$  stress condition.

### 2) Progress B/I Test

After progressing LEO and GEMINI test, progress B/I if small defect or format error occurred.  
A way of detection for HDD defect by reading/ writing the existing written information.

### 3) Flow sheet.

Down load if small defect like mentioned above occurred.(Progress ALT-I in LEO program)  
(Be sure to check download before progress B/I program. Led off if there is no program down loaded or maintenance/cylinder is unreadable.)

As Main and B/I Firmware are separate from VG11/VG11+ series, progress test after changing to B/I Firmware before test.( if B/I finished, change main firmware.)

Check appearance & jumper pin status.

(B/I test is Led off if jumper pin connection is incorrect.)

Connect drive to power supply.(same as drive ready.)

If drive is progressing burn-in regularly, led blink after ready.

If drive is progressing burn-in irregularly, led off after ready.

(Led Off or ready state if the initial state isn't burn-in low or cont-in flow when we check B/I program by loading burn-in program: written by how to B/I flow, SETC 0,SETH 0, SETS 5,(M/C region)

Mark failure and Led frequency appear when lots of defects are occurred or error in drive is occurred during burn-in test.)

Led is repeated one time if pass after done test.

(Be cautious because burn-in test time is different by every model)

Write end-in flow on maintenance/cylinder if pass after done test and write fail-in flow in fail case.

Led blank after write the test result. Pass: repeat one time. Fail: the number of error code.

### 4) Subject of B/I Program

#### Progress B/I Program

- Main order: LED Blink
  - : Format
  - : Change Pattern
  - : Change Sivel Label
  - : Change Retry Count
  - : ECC ON/OFF
  - : Read Track Reverse
  - : Read Track Forward
  - : Write Track Forward
  - : Write Track Reverse
  - : Random Write
  - : Random Read
- Record M/C if error happened
  - : recording location - from CYL 1, Head 0 SEC 1

## 5) Failure status and repairing

Failure state	State	Method	Remarks
Jumper pin connection failure	-LED off after ready when drive is connected.(Not execute burn-in )	-Check the location of jumper pin and execute to change. (The location of jumper pin is always in "-C/D".)	DXX:All sorts of jumper DCF:Size operation pin DSP:Master/slave operation C/D:Master/slave operation
Not down load	-Led off after ready when drive is connected.(Not execute burn-in)  -Order"Can't " is occurred during progressing down load(ALT-I)in LEO program.	-Don't execute down load :execute again.  -Order"Can't " is occurred during re-progressing in down load state,check the drive burn-in state.	-Read cyl:0,head:0,sec:5 on Maintenance/cylinder and check the burn-in program write state.Be sure to be in "Burn-in Flow" state if dump. 1.INIT 0 2.SETC 0 3.SETH 0 4.SETS 5 5.PHRD 1 6.DUMP - Write location according to test result CYL: 0 HEAD : 0 SEC :12 Read Program 1.INIT 0 2.RTRK 3.ADDH 1 4.JLUP 2
MAINTENANCE /CYLINDER read Failure	-Can't read burn-in program so perceive as not down loaded state.	-Error is occurred in reading maintenance/cylinder or no error is occurred in writing&formatting maintenance/cylinder,progress pre-test again or down load then execute Burn -in. -If failure is occurred in entire head during writing or formatting , check out after changing PCBA. -If defect is occurred, catch hold of failure symptom and failure degree then progress operation,execute servo write change disk. (process in head office.)	-Check the error state by reading cyl:0 head:0 in maintenance/cylinder.  -Execute one more heads during writing & formatting not one head only.(Failure can't duplicate if check the same head )
LED failure	-Drive is ready regularly but only led can't run.	-Due to led specific & imperfect soldering - change PCBA then repair.	
PCBA failure	-NO power state	-Execute again after changing PCBA.	
Power cable failure in burn-in rack	-Off condition if power cable is connected to drive.	-Short occur when it is connected drive to power cable, then come to off so unplug power cable and reconnect in 30 second.	

## 8. Caution

Hard disks are very fragile electro-mechanical devices, which are very sensitive to external shock and vibration, therefore be careful when you use not to be impacted and broken by static electricity.

### 1) Handling Damage example from impact

If you move HDD while it is running: Spindle motor of the interior in HDD start to spinning at high speed as soon as power on. Accordingly, if you move HDD without fixing previously when power on, head is possible to collide disk and at this time floating particles occur. And these particles damage to disk then cause failure.

If you dropped or knocked HDD: If you dropped or knocked HDD even though while it isn't running, head collide disk due to vibration of ARM and at this time floating particles occur. And these particles damage to disk then cause failure.

### 2) Damage example for static electricity

Man is easily charged with electricity so if we handle PCBA of HDD, the high-voltage affect on IC or circuit and this become a failure cause.

### 3) Unconsciousness characteristic of product

Keeping the interior of HDD stainless make work regularly without particle of head or disk therefore the interior of HDD is configurated in clean room,after done configuration all cracks through the exterior are sealed by label so if user doesn't recognize this characteristic, disjoint the HDD or remove Label or loose Screw could be a failure factor caused by polluted particle.

### 4) Caution in center

There is such case that failure set is arrived in head S/C attaching label written failure name to PCBA or the connecting part between cover of HDD and base after screen about failure set receipted in center. In this case we have difficulties in repairing because we can't remove label. It still looks like failure appearance after done repairing in case of attaching to PCBA and if attaching label to the connecting part of cover and base, we can't open cover when we need to separate and repair in clean room. Consequently be sure to mark failure name in cover only.

Packaging requirement1 : Be sure to pack with anti-static bag, forwarding to the head S/C as well as sending to customer after done preparing is the same. HDD is very fragile electro-mechanical devices mentioned above, if we don't keep this, failure is getting worse while forwarding.

Packaging requirement2: Be sure to put HDD in direction of 40 pin connect lower certainly. Follow the example form of the head S/C package model. In corrugated card board box,20 block-formed sponges is in the box. Then HDD, piled anti-static bag in each partition, lay in the sponge 40 pin connect is lowered.

## Attachment 1. The basic information related HDD

### The basic information of HDD

#### 1) The logical elements constituted hard disk

**Track:** The data inputted by computer was written at tracks on disk. The tracks, in spite of invisible, are the concentric circles from the center of disk to the outside.

The tracks are divided into spaces regularly. The number of tracks is different according to the size and capacity of disk.

**Sector:** Data are recorded in track on disk, it means data is written on tracks which is divided into sector on disk. The data is written on tracks which is divided into sector on disk. A sector is a piece of pizza, naming track.

**Side:** Disk has two sides like a coin has the front and the back side.

The front side of disk is side 0, the back is called side 1.

**Cylinder:** The definition of cylinder is added the meaning of track and side.

A track 1 on side 1 is different from a track 1 on side 2. But cylinder 0 means the both of tracks in side 0 and 1. That is cylinder 0 means all number 0 of tracks on both sides.

**Cluster:** Disk has physical mechanism that constituted track (divided by the location of read/write head) and sector (divided by track). It's a fact that there is a real logical factor, that is cluster, make the data can read/write.

One cluster consists of two sectors usually. The capacity is 2 Kbyte commonly in hard disk.

But we are cautious that no matter what the data is so small, use one independent cluster.

For example, a cluster occupy 1 Kbyte can't written any other files.

The rest of cluster are useless. If we have 1,025 Kbyte file, we need two cluster to written.

If the size of cluster is getting bigger, the efficiency of disk is lower but the speed of that is faster than.

refer to picture - Track, Sector, Side

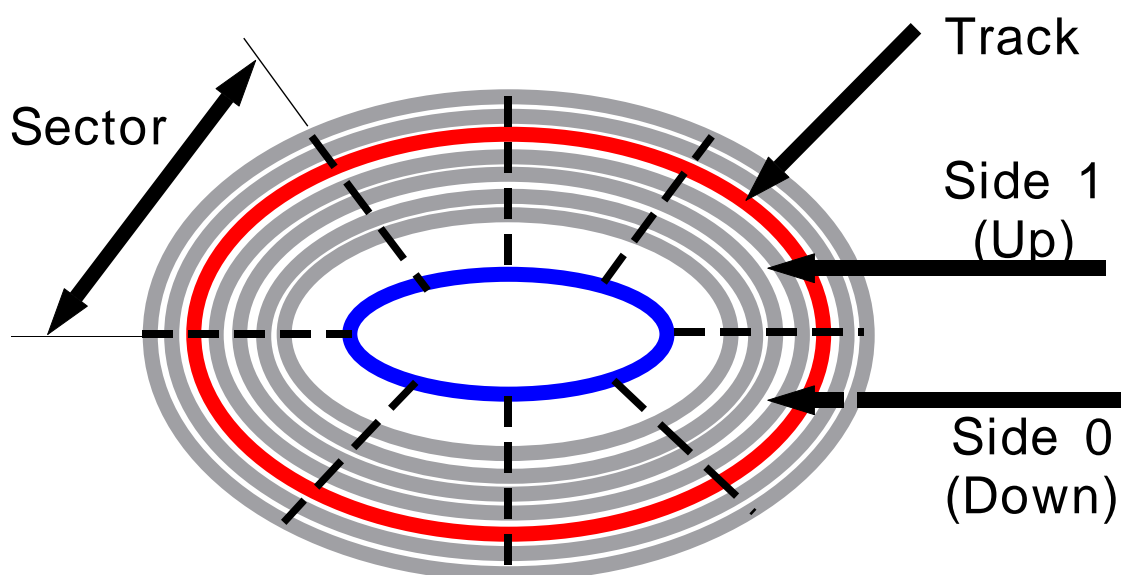

## 2) The logical mechanism of hard disk

Hard disk consists of boot record, FAT, root directory, data field.

Boot Record: Boot record is consists of sector 1, track 0, side 0.

Boot record is the one of most important parts. It has some information about the physical structure of disk. If boot record is vanished, the disk is useless entirely.

The physical information mean, for example, the number of FAT, capacity of disk something like that. Also has boot record also contains programs to make work the operating systems. The program which is capable of working the operating systems is the definition containing several specific information like the number of byte per sector, the total of sectors in disk.

FAT: It says that quota information field: that is the memory field about where the file is located in real data field. Just like we are known the rooms occupied or empty by a hotel account book. Most files occupy several cluster not just one cluster. Cluster belong to a files is scattered in many parts on disk, not existing constantly. If cluster is vanished or destroyed, we don't know the linking state. So we can't read files properly.

Root Directory: All of disk have only one root directory. Root directory exist certainly whether sub directory exist or not. Root directory is the memory field which remember the files on disk and the list of sub directory. And sub directory is treated as files in root directory. Using the disk is restricted when root directory is damaged like as file quota table.

## 3) Terms about hard disk

Seek Time: Seek time is referred to the time that head in disk takes to located a particular piece of data which has information the head want to read. Disk speed is getting faster according to seek time speed. Strictly speaking, seek time of track vs track tell the more accurate disk speed. Seek time of track vs track refer to the time that the disk head which is in present location move to the just next side of sector of track.

Access Time: The access time for disk drives includes the time it actually takes for the read/write head to locate a sector on the disk (called the seek time). For example, the last read head located on track 3 and the next information is located on track 4, the time to try want read(access time) is the same for a seek time of track vs track. But we are not sure the location of the next information we regard this as a average time. This is an average time since it depends on how far away the head is from the desired data, it is similar to a time that head takes to spin a half of the whole track.

Latency: In general, the period of time passing through the unreadable region. Its time is similar to passing time across the half of hard disk circle.

Inter-Leave: The physical sector numbers among the continuous sectors logically on disk. Logical sector is not corresponding to that of physical: the reason is that disk head needs some time can read next sector from the first sector accepting data. Disk head has to keep spinning the while. If a data in sector1 and next data in sector 2:1:1 inter-leave, in sector 3:1:2 inter-leave. 1:1 isn't always efficiency because data of the sector1 receive from memory then try to receive sector2, if the disk is already spun, need one more spin.

Partition : The logical region of disk. Normally disk divides logical region into physical region. The former contains side, track, sector and the latter contains partition. In dos systems, you can partition a disk and each partition will behave like a separate disk drive. Dos recognize two sort of partitions.

DOS PARTITION : This is to dos as system disk is to floppy disk and dos is run by this partition.

EXTENDED DOS PARTITION : The rest region of the disk was occupied by dos partition. The size of partition from dos 4.0 isn't restricted, hard disk over 32MB(to DOS 3.3) must be treated as a independent drive each diving two more partitions.

Transfer Rate: The mass of controller is transferred a data from hard disk. That is transferring to computer after reading the data from hard disk. Transfer rate depends on how faster the disk spin and how many data sector is recorded.

Cache: One of method to optimize capacity of disk drive. Drive using read cache send a data to host computer ,on the contrary write cache used when host send to drive.

Read Cache: How to read the continuous data as well as data needed by host. This is possible because the files in drive storage orderly. If the host want information read before, we transfer information data in buffer without reading dada again. This can be picked up the speed.

Write Cache: All data transferred from host are received in buffer of disk drive, host is informed that written already. While disk drive is recording,host can record another information therefore system efficiency is improved. But this is risk loss of data when power is cut off before recording the data yet. PC use write cache within operating systems like smart drive, so PC doesn't have such like a risk. Disk controller,which manages the interchange of data between drive and computer,and hard ware and soft ware in the circuit of disk controller and disk drive. PC is used AT(IDE) and SCSI interface normally.

Disk controller,which manages the interchange of data between drive and computer,and hard ware and soft ware in the circuit of disk controller and disk drive. PC is used AT(IDE) and SCSI interface normally.

IDE Drive: Abbreviation of Integrated device electronics. This drive make all circuits connected to AT bus directly by putting within drive, we call this general AT drive.

Enhanced IDE: Current IDE spec only two drive can be attached and the speed isn't fast. The higher capacity of system,the lower that of the whole system due to that of HDD. Enhanced IDE is an improved IDE-AT Interface spec. resolve the problem like lower transferring speed and 528MB barrier cause by current BIOS. Fast-IDE Interface or local bus IDE-AT Interface are the same.

SCSI: Current IDE spec only two drive can be attached and the speed isn't fast. The higher capacity of system,the lower that of the whole system due to that of HDD. Enhanced IDE is an improved IDE-AT Interface spec. resolve the problem like lower transferring speed and 528MB barrier cause by current BIOS. Fast-IDE Interface or local bus IDE-AT Interface are the same.

Defect-Free: A region isn't able to read exist in media. When we find defect like this in manufacturing process, we replace with the normal region. Thus we can supply perfect drive to user. Defect magnet is a method can arrange the defects in read/write from the replaced sector.

ECC On-the-Fly: A region isn't able to read exist in media. When we find defect like this in manufacturing process, we replace with the normal region. Thus we can supply perfect drive to user. Defect magnet is a method can arrange the defects in read/write from the replaced sector.

Multi-Zone Recording: Zone-bit recording or constant recording are the same. In case we record data on spinning disk in constant frequency signal, shorten the inside caliper and lengthen the outside diameter. If we make this evenly, the capacity of drive is improved.

Master/Slave/Cable Select: When we attached 2 IDE drive, one is master and the other is slave. Being a M/S whether or not of drive is determined by jump in drive or cable select.

BPI: Abbreviation of bit per inch, recording density towards a circumference. Usually we decide the maximum diameter of track.

Buffer: The RAM where executed data between HDD and host computer is stored in RAM temporary. The resolution of the bottleneck according to difference of speed and improving the efficiency.

Controller: Same as disk controller, chip or circuit make possible transfer command and data of computer according to HDD.

DMA: Abbreviation of direct memory access, a technique for transferring data from main memory to a device without passing it through the CPU. This is useful for making quick backups and for real-time applications.

Servo

Local control technology enable to read and write data. When spinning flatter high-speeded read data, head is the accurate position according to the position written data, this technology could be a standard about HDD efficiency. Local controller apply stepping spindle motor or voice coil motor to head located in actuator and settled a position.

More over another important factor is how far the magnetic head could fly on the surface of hard disk. The lower the height of magnetic head is, the narrower the magnetic region on the disk surface, so the more data can be read or written on the same disk surface.



## Attachment 2. Explanation of HDD terms

Access	Read, write, or update information on some storage medium such as a disk.
Access time	The interval between the time a request for data is made by the system and the time the data is available from the drive. Access time includes the actual seek time, rotational latency and command processing overhead time.
Actuator	The internal mechanism that moves the read/write head to the proper track
Allocation	The process of assigning particular areas of the disk to particular data or instructions.
Allocation Unit	An Allocation unit is a group of sectors on the disk that can be reserved for the use of a particular file. (usually in the form of sector, block or cluster)
Buffer	An area of RAM reserved for temporary storage of data that is waiting to be sent to a device.
ABS	Air Bearing Surface. Establish flat surface slantingly at the both sides of head to make head rise on disk by using air pressure.
Access	Reading, writing, updating information stored in disk.
Access time	Time from requesting data to assuring data on disk in system. (contained seek time, rotational latency, command processing overhead time)
Actuator	Mechanism of making read/write head move to the proper track.
AFR	Annualized Failure Rate. Accumulated failure rate.
Allocation	Process of storing Data instruction at the particular region in disk.
Allocation Unit	Remaining sector set on disk to be used for specific file. (commonly, in form of sector, block, cluster )
APM	Advanced Power Management Hardware.
Areal Density	Recording capacity per 1 square inch. Areal Density = BPI × TPI [Mb/Inch]
Arm	Assembled HGA(Head Gimbal Assembly) and VCM at the back and forth of ARM. Parts which is connected to pivot bearing of base. (Parts enable to move head to proper location on Base physically)
AT	Advanced Technology interface or IDE. Interface to be designed for IBM transfer PC.
ATA Device	AT Attachment Device. Device is equivalent to ANSI ATA spec. HDD, contained tape drive, CD-ROM.
ATA-2	Improved the existing AT interface, Interface is correspond to E-IDE of W/D by suggestion of Seagate
Audit	Examine the factory.
Average Seek Time	The average time it takes for the read/write head to move to a specific location.
Back Gap	protect information recorded in media from damage by breaking the remained current flowed to head in magnetic body.
Bad Block	A block (usually the size of a sector) that cannot reliably hold data because of media flaw or damaged format markings.
BALANCING PLATE	Lead plate to maintain the balance of ARM. (The amount of disk and head are different in case of different capacity of the same series, so this maintain the center of gravity because the center of gravity of ARM is changing according to those of head changing. )
Base	Basic frame for parts assembling of HDD. spindle motor, arm, VCM, cover, PCB are assembled on Base.

BEARING	Abbreviation of pivot bearing, Mediator of Arm and Base which is located in the center of ARM and it can rotate smoothly.
Bezel	A plastic panel that extends the face of a drive so that it covers a computer's drive bay opening.
BIOS	Basic Input/Output system: Control program/sub-program can control computer and around device.
bit	A binary digit may have one of two values-1 or 0
Boot Record	Located in the first track and sector in disk where store physical structure information of disk. (sector1, track 0, side 0)
BPI	Abbreviation of Bit Per Inch, it means the recording density towards circumference. Generally it decided to the value of maximum track.
BPS	Bit per second. Data transferring speed, transferring bit numbers per second.
BPSI	Bits per square inch = areal density, Bit numbers per 1 square inch, $BPSI=BPI \times TPI$
Breather Filter	Filter to prevent contamination occurred inside due to outside air, it is putted on air plug.
Buffer	Temporary RAM to store data between HDD and host computer, it is used for efficiency improvement.
Burn-in test	Reliability test with changing temperature, voltage condition.
Bus	The part of a chip, circuit board, or interface designed to.
Byte	Unit of digital information. 1 Byte is 8 bit.
Cache	Optimizing method for drive efficiency, read cache is for data transfer from drive to host computer and write cache is from host to drive. (256KB in normal. It mediate the bottle-neck due to speed difference between drive and PC host)
Capacity	Information amount could be stored in HDD. Units are MB, GB
Clean Room	No particle room for MP or RMA of HDD. Grade of 1000ppm, 100ppm, 10ppm etc.
CLIP-FPC	Components to assemble FPC and SUPPORT-FPC.
Clock	Timing standard signal to treatment balance.
Cluster	The logical factor to read/write real data. One cluster is bind 2 sectors generally, its size is 2kbyte.
Compatibility test	Test hardware device or software's compatibility to confirm compatibility.
Controller	Disk Controller also, chip or circuit can be transfer data order of computer to available to HDD.
Cover	Protect parts within HDD from the exterior impact and particle and moist ,the fatal fact caused head and disk failure.
CPU	Central Processing Unit. Control input/output device and sending, computing,recording data and output the result.
Crash Stop	Protect activator's impact in emergency condition when head move to parking zone or come off data zone.
CRC	Abbreviation of Cyclic Redundancy Code, detect error differ from ECC containing error correcting function. For protect ID data.

Cylinder/Track/Sector	Data is recorded on lots of circle in media in HDD, we call these circles track.. We record data at both sides of media and HDD has many media layers. so it has several tracks which have the same radius, we call this concentric circle collection of track Cylinder. Tracks are divided to sector and it organized ID information and data and ECC. ID information is a sort of address information to seek data sector requested from host computer.
Data Separator	Separate complex data/clock signal from HDD stored data/timing information encoded form.
Decoding	Restore encoded signal.
Dedicated Servo	Concentrate servo signal (Timing & location control signal) on one side of drive.
Defect Management	Find defect and treat data from replaced sector on read/write.
Defect-Free/Defect Management	HDD vendor received disks from media vendor for smooth supply and proper price and these media has defect( region can't read write data), by scanning defect during production process and replacing normal region so we can product defect-free drive. Defect management means scanning defect and treatment process from replaced data during read/write.
Disk	Head record data in this circle plate, magnetic disk is general.
Disk array	Group assembled the separate HDD for large capacity.
DMA	Direct Memory Access, data transferring method among system memory and HDD without CPU. By using DMA, CPU can do other works while data transferring, efficiency become improved.
DOA	dead on arrival, arrival failure.
DPPM	Defect parts per million, failure unit.
Drive Geometry	Functional definition according to the numbers of head,cylinder,sector per track.
DVT	Design Verification test.
ECC	Error correction code. Correct error data, controller scan and correct error combining user data and parity bit.
ECC on-the-Fly	ECC is Error Correction Code, Additional recording information per every sector. By ECC creation logic, data is added on disk and checking and correcting with reading. If it is correctable error without read action stopping, we call this ECC on-the-Fly with hardware's help within controller.
E-IDE Enhance IDE	Revised interface in IDE way, new specification to improve the existing method has problem of low speed.
Embedded Servo / Dedicated Servo	Embedded Servo: Arrange servo signal(timing,location control signal) to data and data track in parallel. Dedicated Servo: Mechanism of dedicated surface of disk have timing and positioning information only.
Encoding/Decoding	Encoding is a data transferring method before recording data pattern to disk and Decoding is on the contrary. To read recorded data more easily and accurately, Encoding and Decoding should be needed. Coding methods are MFM.(2.7)RLL.(1.7)RLL.

Enhanced IDE	The existing IDE specification enable to adhere only 2 drives and transferring speed was low. But HDD efficiency are resulted to low the whole capacity according to getting system efficiency higher. Enhanced IDE has specification of revised IDE-AT interface by current BIOS and 528Mb barrier and we settled the low speed problem with this new spec. Same as Fast-IDE Interface or Local Bus IDE-AT Interface.
EOL	End of Life.
EPROM	Erasable programmable read only memory.
EVT	Engineering verification test.
FAT	File allocation table. Data table is recorded at the most outer side of disk, inform sector location and order of each recorded file to Operating system.
FCI	Flux change per inch. magnetization rotation density per unit inch.
FCI/FCPI/Flux Density	Flux Change Per Inch. Magnetization rotating density per unit inch. Concerned with BPI, this value is decided by track has maximum radius. BPI is proportion to FCI according to difference of coding method.
FDD	Floppy Disk Drive. 5.25"/3.5" drive is used for PC
FILTER	Components filtering particle from the flowed air to the inside/outside of HDA.
Firmware	Hardware control program, this is stored in
Flash Memory	Among PROM of the memory for searching only which can re-write, memory chip enable to rewrite and erase the old contents electrically.
Flexure Assembly	Control rising by Slider ABS, flying height of slider and make slider move to proper track by connecting to head positioning mechanism.
Flux Density	Flux density, the number of magnetic field pattern can be recorded on the disk surface.
Flying Height	Distance between Read/write head and disk surface. Air resistance due to disk rotation can maintain this distance, the small flying height is, the large data recording density is, but it need more specified mechanical design.
Form factor	Industrial specification decided diameter of Disk. 3.5", 2.5" in case of Samsung.
Format	Recording the particular signal to divide track and sector and this information should be recorded on disk in first before user want to store data. Be careful because formatting erase all recorded information.
Formatted capacity	Available HDD capacity after HDD formatting.
FPC	Flexible Printed Circuit, or PCC, inputted parts enable to flow current to the flexible material. (Polemize)
FPC ASS'Y	Status of soldering IC, CAPACITOR, 14PIN CONNECTOR to FPC surface or connecting HOLDER-FPC, SUPPORT-FPC, CLIP-FPC.
GASKET	Parts made of rubber to protect inner inflow air and moist from the outside of HDD
GigaByte(G B)	Data storing unit. Accurately 1,073,741,824 bytes(1024*1024*1024), i.e. 1,000MB
GMR Head	Giant Magneto Resistive head. New type head of MR head.
Half height	One of the standard height specification of HDD and the real height is 1.6inch
Hard Error/Soft Error	Hard error is a continuous misreading due to defect of disk surface) and it can read correct data if in case of read again, we call this soft error.
HDA	Head Disk Assembly, half assembled product of HDD. SPINDLE MOTOR, DISK, HSA, VCM etc. are sealed within Base and Cover.
HDA label	Label remarked assembly status of Disk/Head by 5digit-english & number.

HDD	Hard Disk Drive, memory device by transferring data to permanent magnetic field rather than digital pulse. It organized HDA and PCBA.
Head	Read/write data on disk directly. (MIG, Thin film, MR,GMR)
Head Crash	The damages of read/write and media cause a sudden contact between head and disk surface, they are also occurred because of dust,particles or other contamination within HDA.
Head Stack	Status ARM and HGA assembled.
Height	Vertical height of HDD ( 1 inch height is used generally in case of 3.5" drive)
HGA	Head Gimbal Ass'y, recording and replaying data and it organized slider and suspension for supporting slider, usually we say Head..
High-Level formatting	Progressing mechanism to format program of management system. Root directory, File allocation table created.
HOLDER-FPC	Parts made of plastic enable to make routing FPC.
HSA	HEAD STACK ASS'Y,. Assembled HGA with FPC ASS'Y in ARM.
Hz	Herz. The number of event during 1 second.
I/O	Data Input/output
IC	Integrated circuit.. Electric circuit,assembly of elements of transistor,diode,resistance on the thin plate of semiconductor. CPU of PC and RAM are sort of IC.
IDE	Integrated Device Electronics. In IBM PC AT, drive type enable to connect all circuits to AT Bus directly
IDE Drive	Integrated Device Electronics, In IBM PC AT, drive enable to connect all circuits to AT Bus. Generally, AT drive.
Initialize	Refer to low level formatting.
Interface	Disk controller to manage data between drive and computer and hard ware & software contained within disk drive circuit. AT(IDE) and SCSI interface are usually used in small computer system.
Interleave/ Interleave Factor	Order of sector arranged within track. For example, interleave factor is 3:1 then arranged by 3 sectors for sector interval, that is, it is possible to read sector2 after reading sector1 by leaping over 2sector. We need 3 rotations to read all data of track. Now days, Most interleave is 1:1.
IQC	Incoming quality control. Inspection process for import.
Jumper	Device in type of hardware, it decide HDD connecting status (Master/Slave etc.)
Jumper Pin	A small parts enable to choose drive running mode.(Master/Slave)
KB/MB/GB	KB = Kilo Byte, MB = Mega Byte, GB = Giga Byte. K,M,G have double meanings. First, K=1000, M=1000000, G=1000000000, second K=2 <sup>10</sup> =1024, M=2 <sup>20</sup> =1048576, G=2 <sup>30</sup> =1073741824. The second one is more accurate mean on HDD capacity, but we usually we use by the first one.
Landing Zone/Parking Zone	Both of them means the landing location of head when spindle motor stopping. This zone used for protecting the risk of data damage caused from the contact between head and disk, this zone is not stored. Recently most drives using VCM are designed head should be landed in landing Zone automatically.
Latch	Parts enable to hold ARM putting on head in constant power.
LATCH SCREW	HEAD is located in parking zone on off, at this time latch screw connected in parking magnetic and make head fixing. (latch force is determined by magnetic power )
Latency/Rotational latency	Waiting time until target sector seek time after Read/Write Head arriving at the target track. (Generally, 1/2 of spindle cycle ). One cycle time of disk is 16.7ms in case of spin speed is 3600rpm, then average waiting time should be 8.3ms. This Latency is a one of most factor for drive efficiency, transferring speed is better getting shorter waiting time.

LBA mode	Logical block allocation. DOS mode to resolve 528MB capacity restriction.
LED	Light Emitting Diode. Used for signal light to all kind of electric containing computer.
Low profile	One of standard height of HDD, the real height is 1 inch.
Low-level formatting	Operating system make sector on disk enable to access in proper region in order to create file structure.
Master	HDD become booting when put 2 more IDE drives. (decided C:, Managed master/slave by Jumper control & CMOS setup)
Master/Slave /Cable select	When 2 IDE drives operated, one drive become Master(drive C: or drive 0) and the other is Slave.(drive D: or drive 1) Master/Slave is determined by using jumper within drive or Cable select method. jumper setup is different from companies,so refer to usages, Cable Select has a complex jumper method so drive become master/slave automatically according to decided signal for Cable Select..
Media Aluminium	Plate substrate coating with magnetic body. Casting with lubricant to prevent damage for Head landing/off, where data stored in form of magnetic flux or politory change.
Mega Byte(MB)	Data storage unit. Accurately 1,048,576 Bytes(1,024*1,024). that is 1,000KB
Mega Hertz(MHz)	Clock speed unit for PC, clock occur million times per second
Microprocessor	Collection of CPU function to LSI( large IC).
MIG	Read metal in gab head, Improved head has high valued inductance by inserting metal around gab of core.
Millisecond	One thousandth. Speed unit of HDD efficiency.
MMX	Multimedia Extension. Intel's new CPU chip. Added new 57 orders to run image and sound, efficiency is improved about 10~20%.
MP	Mass production.
MPC	Multi-media Personal Computer
MR head	Magnetic Resistive head. For high-efficiency HDD, IBM developed the marginal head which is enable to separate read/write applying MR elements to read head of thin film head.
MRB	material review board.
MTBF	Mean Time Between Failure, average time of occurring failure. This is one of most important reliability factor, not the actual measured value but the calculated value of every companies.
MTTF	Mean Time to failure. same as MTBF
MTTR	Mean Time To Repair, average time to repair. Generally the replacing time of PCBA or HDA.
Multi-Zone Recording	Zone-Bit Recording, Constant Recording. While recording data on rotating disk, the inside diameter get shorter of sector length and outside diameter get longer of that if the frequency of signals is constant. So we make drive capacity higher if make the sector length same with outside diameter and inside diameter. We also say Constant Angular Velocity, CAV and Constant Linear Velocity, CLV.
MVT	Maturity Verification Test, Test for MP possibility.
ORT	On-going reliability test. Test for MTBF and long time test in normal condition. ( Burn in test progress with mal-condition)
OS	Operating System. Control and manage computer system to use more easily for user. (DOS, UNIX etc.)
Outer Crash Stop	Parts decide outer range as ARM can move, this parts is a stopper of HEAD out of DISK.

Overhead	Time to perform the real order for controller, host adaptor and drive. The faster overhead is, the faster performing time.
Overwrite	Recorded data erased by overlapping the existing data.
Parking Zone	= Landing Zone
Partition	When we use one HDD for multi ones dividing section logically, every memory section is partition, For example, 2.5GB HDD can be used for one 2.1GB computer and one 400MB.
PCBA	Printed Circuit Board Assembly. Kind of IC and Chips are Soldered on board and make run HDA, PCBA is a half-finished goods.
PCMCIA	Personal Computer Memory Card International Association.
Pentium	586 Microprocessor to apply IBM type developed by Intel
Pentium Pro(P6,686)	Pentium's next CPU. 5.5 billion transistor integrated. There are 150, 166, 180, 200MHz.
Peripheral	Additional device except basic CPU. There are Disk Drive, Tape Drive, CD-ROM.
PIO	Programmed Input/Output.
Pivot Bearing	Roll bearing is fixed on the rotating center of ARM.
Plated Media	Disk is covered with hard metal alloy rather than disk Iron-oxide compound. The more data could be stored.
Platter	Metal disk record data within HDD
POH	Power On Hour, used for MTBF.
Power PC	RISC type CPU is developed by IBM, Apple and Motorola commonly.
PQT	Pre-qualification test
PRML	Partial Response Maximum Likelihood, this is a read/write method to improve record density and data transferring rate. This method enable to improve capacity as 30% more than the existing data transferring by using Peak Detection.
PVT	Production verification test
QMS	Quality management system. Overall quality management system
RAID	Redundant Arrays of Independent Disks. To protect a sudden data damage, connect HDD in parallel and diverge data, that is high speed back-up device enable to improve data preservation and low speed access for tape the problem of the current back-up device.
RAM	Random access Memory. Semiconductor memory enable to input and search,we have DRAM and SRAM.
Read cache	Look-ahead method is not only reading data requested from host but also reading- ahead continuous data to buffer sequentially, We improve data transferring speed because we don't need to read again in time host request information pre-read by applying for file's sequential saving method.
Read Sector/Read multiple/Read DMA	Order of reading all data from HDD, read sector occur interrupt per every sector transferring, read multiple occur interrupt per designated sector number by set multiple order. Also read DMA occur interrupt only one time after transferring data from host request. For example, 4 is chosen by set multiple and host need 10 sectors then the below picture draw how to occur Interrupt.
Recoverable Err/Unrecoverable Err/Correctable Err	Similar to Soft Hard err. Recoverable err means it is possible to read normally though data was read wrong, unrecoverable err means it is impossible to recover error by any means. Correctable err is belong to Recoverable err, this is recovered by software ECC.

RETAINER RING	Component could fix bearing when inserted to ARM.
RLL	Encoding method "run length limited data" to magnetic pulse. It can store data 50% more than MFM(Modified Frequency Modulation) method.
RMA	Return Material Authorization
ROM	Searching only memory. memory would not erase during off, so we use this to program or data need not change in PC. Mask ROM input contents when it's manufactured and PROM recorded program by user.
Root Directory	The place where file on disk and sub directory list.
Rotational Latency	Time which controller find proper data with track rotating, head read/write. Generally 1/2 of full rotation hour.
RPM	Revolution per minute. RPM is higher. the data searching speed is getting higher.
SCSI	Small Computer Systems Interface. IDE drive can put only 2 drives on the same bus (4 drives in case of Enhanced IDE), SCSI can put 8 drives on the same bus. Also it can be connected HDD and other various device,CD-ROM, Tape drive, Printer etc. as well. 16 bit Fast SCSI can transfer data in 20Mb speed per second. Apple Macintosh and UNIX operating system use mainly.
Sector	Minimum classification unit which assigned by drive to store information.
Seek	Moving read/write head to the particular data track.
Seek time	Time which head is located the current post move to another head written information should be read.
Server	Computer and device to produce every server to PC on PC LAN network.
Servo	Control system in feed-back way to move the accurate location in device, Signal recorded pattered disk in every side to be capable of HEAD location controlling.
Servo Data	Magnetic marking written within media enable to move read/write head to accurate location.
SERVO-WRITER	Servo information recording equipment on HDA assembled.
Settle time	Time which head read/write the real data after arriving on proper track.
Shock Rating	Enduring number without disk drive damage.(G unit) It is differ according to run/unrun number.,
Slave	In case, several PC is connected to one PC, the rest drives except booting system(C:)
Slider	The core part of head ass'y, made for head can surface on disk, it's organized ABS, Core, Coil in general.
SMART	Self-monitoring, Analysis and Reporting Technology. Technology of reporting the HDD inner status and analysis to Host.
SPC	Statistical Process Control.
Spindle	Center shaft of drive connected hard disk platter.
Spindle motor	Motor enable to rotate disk in continuous speed. (high speed:4500rpm,5400rpm etc)
SSA	Serial Storage Architecture. High speed and high efficiency interface technology of IBM correspond to Seagate's FC-AL interface.
Track	HDD have numerous circles in media, and these circles write data, we call this circle track.
Track density	Track density (attachment: TPI)



Transfer rate	Data transferring speed among PC and other devices of HDD.
Tri-pad head	The existing thin film head have 2 ABS and adding one more ABS, head is designed to be profitable to low flying height. Produced by SAE, ReadRite company.
Ultra ATA/Fast ATA	
Unformatted capacity	HDD capacity before formatting.
USB	Universal Serial Bus. Particular chip was connected in period plate and manage keyboard, mouse, printer,modem, this chip unify the connecting pot shape of other device period plate, then make easy to connect and speed is 10 times higher than the current vertical connection.
VAR	Value Added Re-seller. Vendor sell the existing product after making higher value added.
VCM	Voice Coil Motor: Stable and high speed motor applying speaker system, make move head in proportion to magnetic strength. Motor used voice coil has fewer components than step motor so it is strong for stress and abrasion and move head in high speed. They divided Rectangular and Flat coil type of VCM according to shape and Linear and Rotary type according to rotation method. Recently flat coil type and rotation type is general.
VCM COIL	Trapezoid shaping parts connected to ARM with winding coated write in 250 times.
Winchester Disk	Disk drive same as fixed Disk and hard Disk. Winchester was the of developing model at that time by IBM, establish fixed magnetic disk within airtight space then head rise on connecting disk, we apply to all kind of hard disk drive now days.
Window Clock	Make hole so head for servo write to write locational information could enter inside of HDD.
Window Pusk Pin	Pin hole to enter HDA.
Write cache	Write cache improve system capacity, i.e. make possible to work while recording information on disk and this is risk to loose data when off but PC use write cache within operating system like smart drive to prevent that risk.

## Attachment3. Q&A

Customer's Q&A

### 1) What is "Bad Sector"?

Bad sector is divided physical Bad sector(Hard defect) and logical Bad sector(Soft defect).

Physical Bad sector

Visual defect occur in the surface of disk where is recorded data, it contain the minute defect could checking with electric microscope. The main occurring cause of physical bad sector are particle, impact, vibration. Among them, impact is the most serious cause, this affect other components and bad sector as well and get weak HDD status( noise, bad sector).

Logical Bad sector

We can't find physical error on the surface of disk where the real data recorded but actually abnormal data recorded in this case. Physical bad sector occur due to sudden effect(stoppage, unstable power, head mis-running due to impact/vibration, unstable finish, Virus, collision with other hardware). But real data storage could not damaged, if you over write data again, you can use newly recorded data without problem.

But you'd better HDD installation in state of manufactured in factory to prevent next data error.(After data back-up)

Resolution for bad sector:

Self-examination by Shdiag program.

Progress low level format with clear HDD program.

### 2) The real product capacity is not consistent with capacity on window screen.

The reason of 4.3GB is displayed instead of 4.0GB is follows.(e.g. 4.3GB)

Generally 1K = 1000, but 1K = 1024 in case of computer.

The reason is that computer and OS can perceive only two number, 0 and 1.

So 10 square of 2 is recorded as 1024. ( $2^{10}=1024$ ) User's capacity of HDD is 4,300,000,000 Byte, it is not changed but due to computer perceiving restriction method, it looks capacity was reduced. Consequently remark is changed according to unit change, the real capacity is not changed.

### 3) What is LBA, Large and Normal mode ?

LBA and Large mode of HDD is one of the method to recognize the high capacity HDD of 528MB more. LBA mode has been applied to SCSI, it recognize cylinder, head and sector

by the way of not three-dimensional but one-dimensional and numbering the first sector in form of block unit is to number 0 then the sector become a unit and the assigned number become a address, then change those numbers into physical three-dimensional address of cylinder, head and sector. At this time, LBA mode is useful if BIOS and Hard is applied.

In case of Large mode, if the number of cylinder is in between 1024 2048, divide that value then multiple the number of head and we can use HDD which doesn't apply LBA mode by setting for this method and we can just establish HDD capacity until 528MB in case of Normal mode. But we don't produce HDD in normal mode any more. The difference of Large and LBA is that LBA is recognized as the number of cylinder was reducing in half and the the number of head was raised double and Large mode is set as the same way of general Normal

mode, and extend capacity by raising the number of cylinder. Currently most of hard disk is applied to LBA mode, so it set as LBA or AUTO in BIOS set-up.

**4) PC is downed with the message of "Stack Over Flow" while HDD running or can't recognize HDD.**

If internal stack overflow error occurred on the basis of MS-DOS system (MS-DOS, MS-WINDOWS95), increase the number of internal stacks of CONFIG.SYS file and the usages are as follows.

STACKS=number,size

This number means the number of stacks (it is possible to designate by 8-64, Default 9), and the size means stacks' size. (32-512, Default 128)

"Internal stack overflow" occur on using the program which can make memory assigned stack region apply hardware work, and also this problem occur during progress of RAM residential program or applicable program on the basis of non-windows system.

**5) Bad Sector often occur.**

Hard disk is supported by IDE system under the 486 computer. IDE system can set to the extent of 2 hard disks and though it was set high capacity hard disk, the real capacity is up to 528MB. From 529MB, EIDE( extended IDE) type supporting computer recognize as Bad Sector. If your computer doesn't support EIDE, you can use disk manager program, you can download this in utilities of our web-site.

In times of CMOS set-up, make Hard disk recognized as Auto Defect in EIDE supporting computer and make HDD mode to LBA if BIOS is AMI,Award.

**6) Parking should be necessary when turn PC off?**

HDD which can't supporting Auto parking has been damaged by stopping read/write head on data region if it is off suddenly. To protect this problem, we have to move head to parking region by parking program but we need not progress additional parking program to move head to parking head.